

option "b"

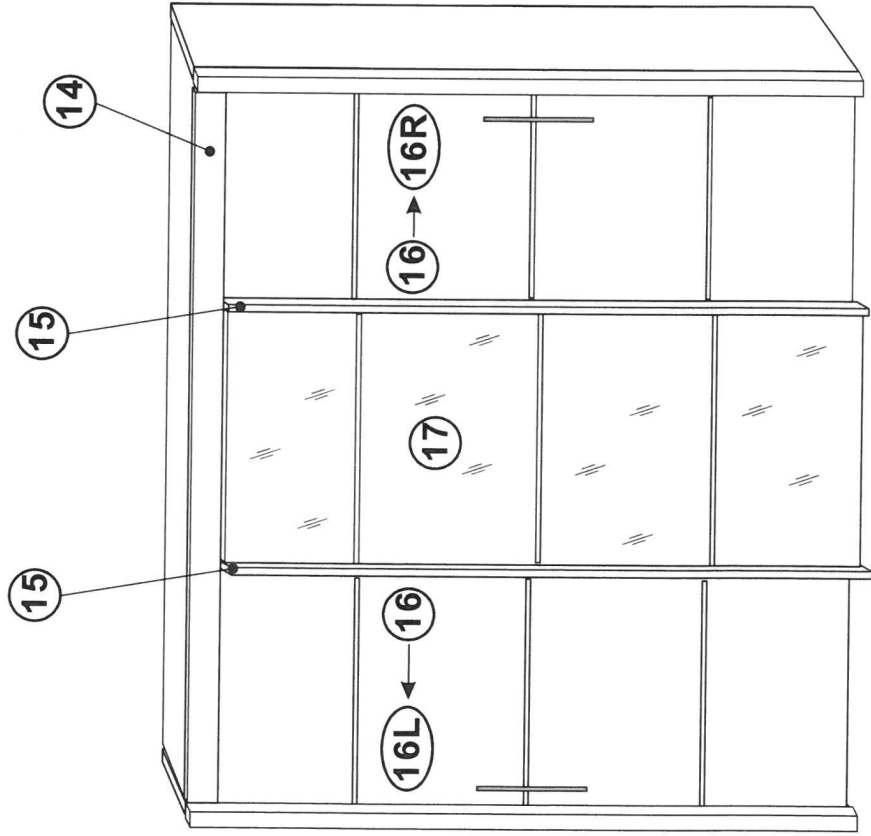

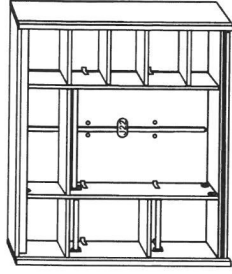

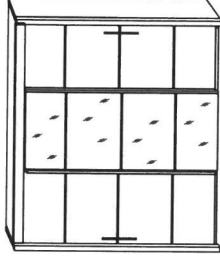

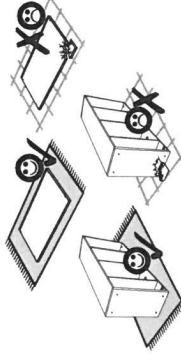
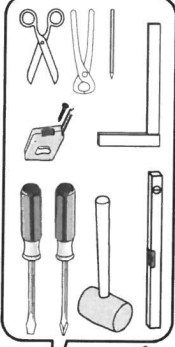
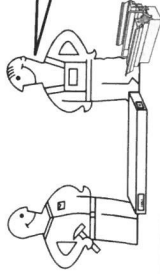
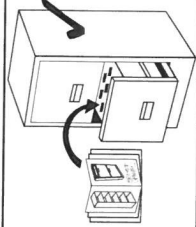
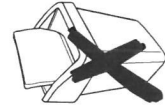
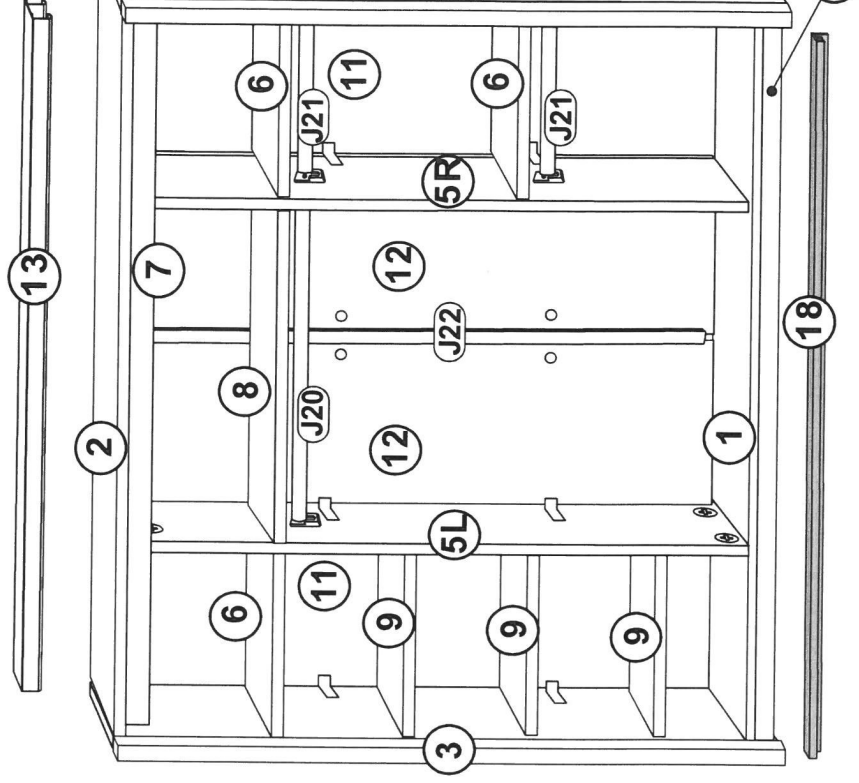
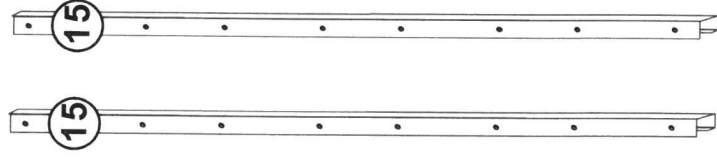

option "a"



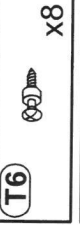
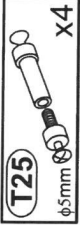

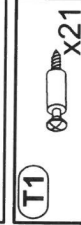

1

L1		x4
-----------	---	----

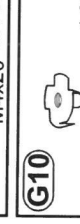

2

B1		x18
T6		x8
T25		x4
M1		x21
T1		x21
K1		x4
M6		x14
P16		x14



3

W1		x12
P13		x10
A1		x10
G10		x10
E49		x4
C14		x26

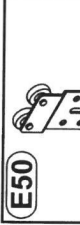

4

F7		x6
S3		x6



5

E50		x4
E1		x16



6

E51		x2
E1		x8





7

E4		x4
E1		x8
E5		x4

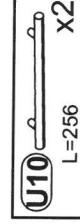
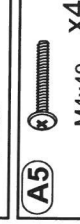

8



E3		x2
E1		x4
E5		x2

9

U10		x2
A5		x4
P13		x16
L4		x3
L5		x2

10



J11		x2
P13		x4



J20		x1
J21		x2
J22		x1

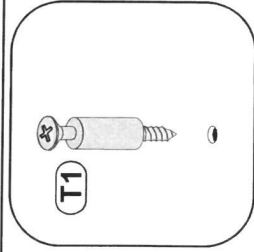



1 option "a" 







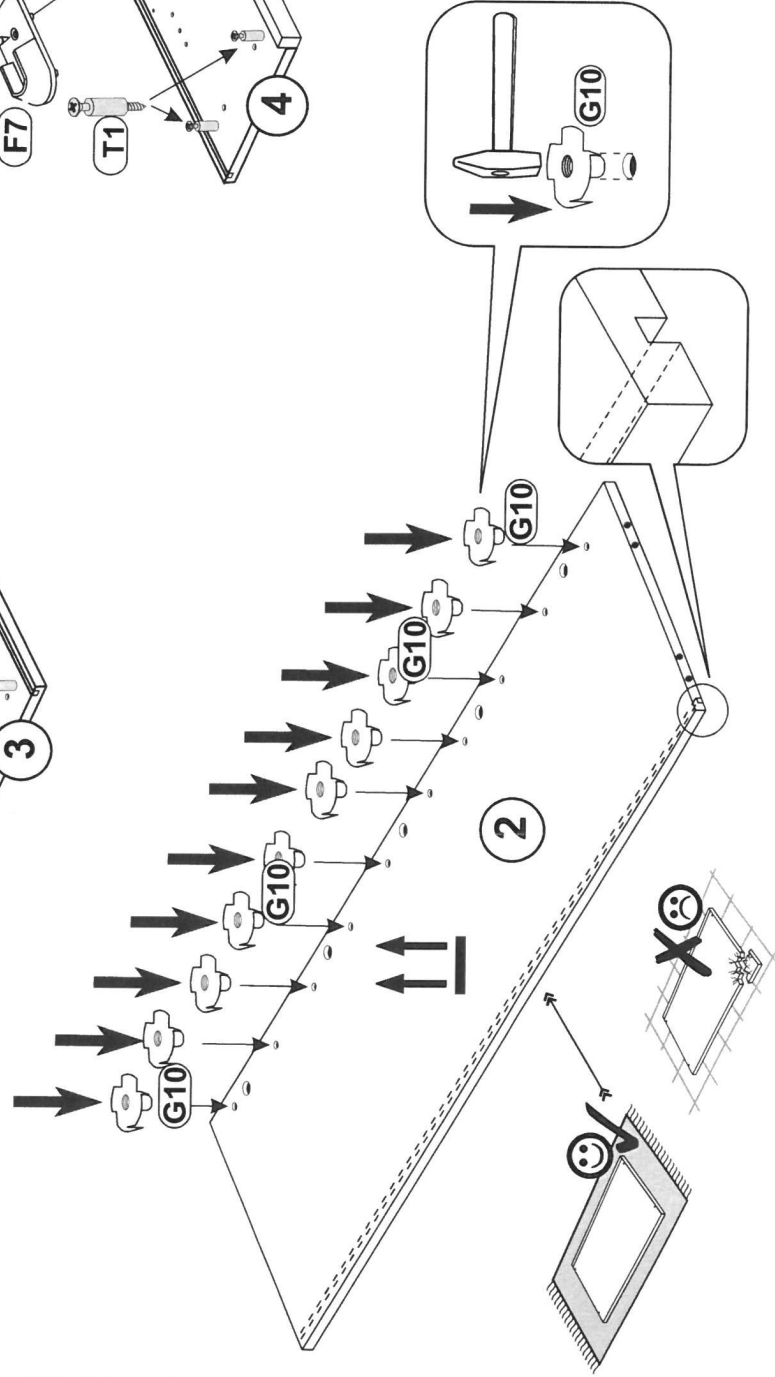
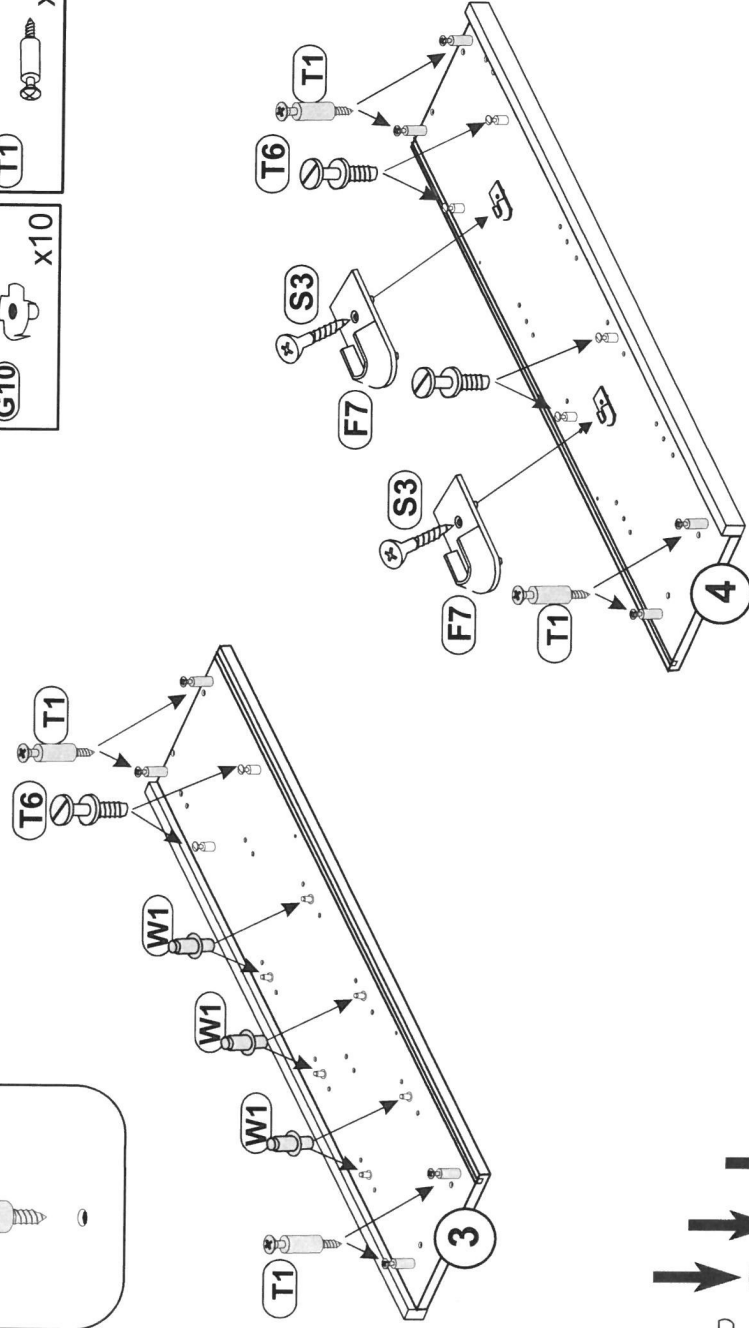

	x6
	x10

	x6
	x8

	x2
	3,0x13 x2





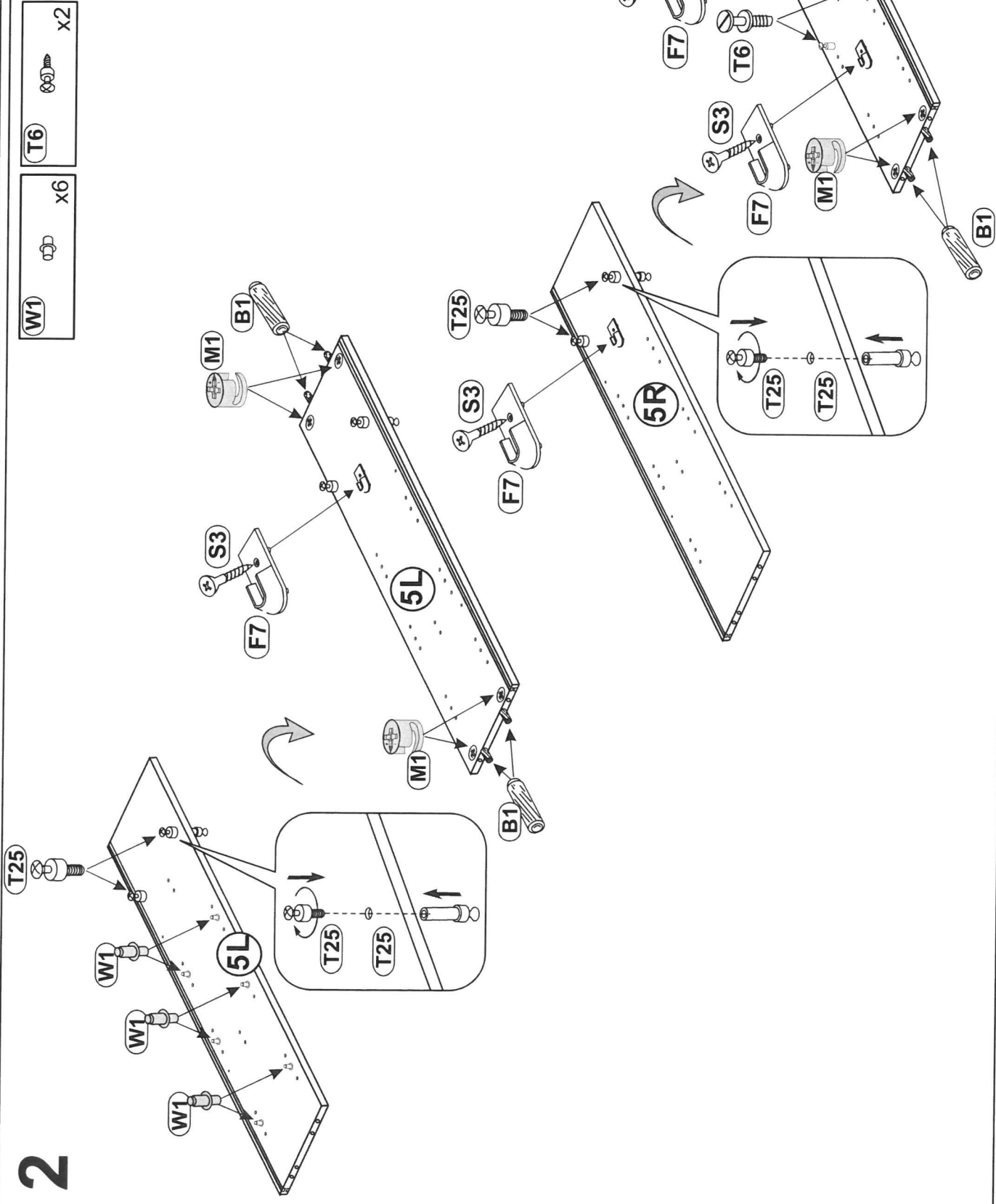

2

W1	 x6	T6	 x2	F7	 x4	B1	 φ 8x28 x8
				S3	 3,0x13 x4	M1	 x8
						T25	 φ5mm x4

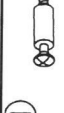
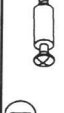

3

- L1**  x4
- M1**  x4
- T1**  x4
- B1**  x4
- B1**  ϕ 8x28 x6
- P13**  3.5x13 mm X10

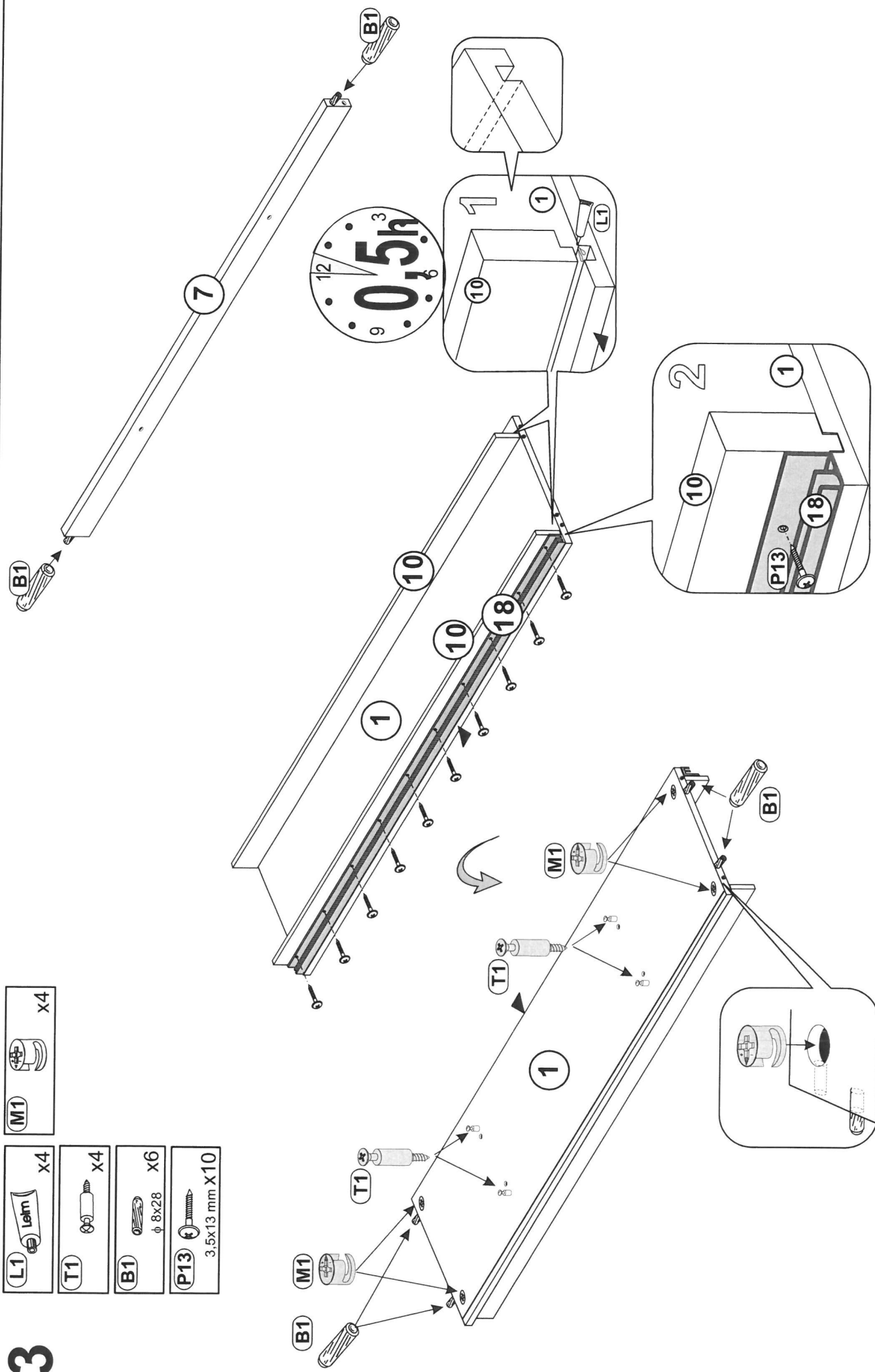

4

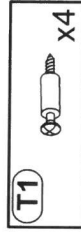
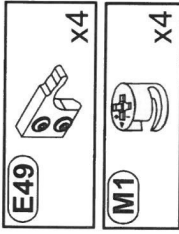

2

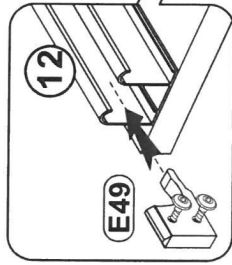

3

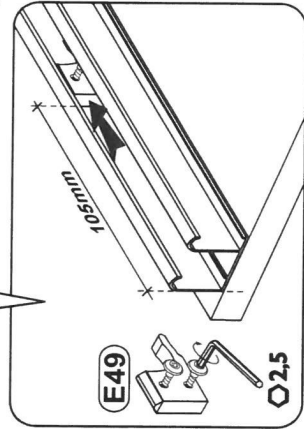

4

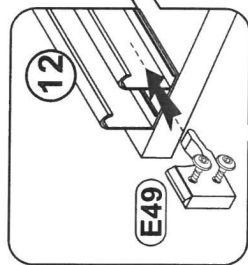

5

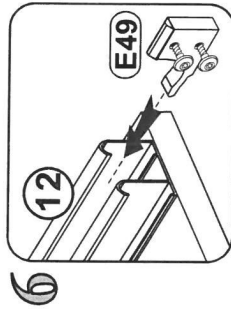
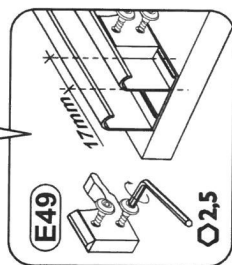

7

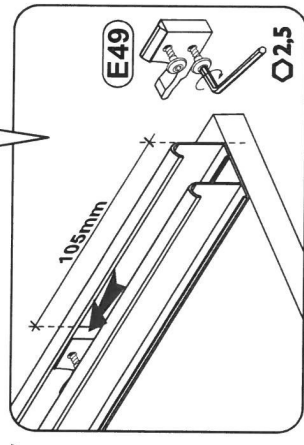



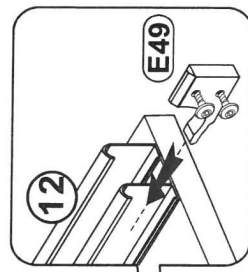

8

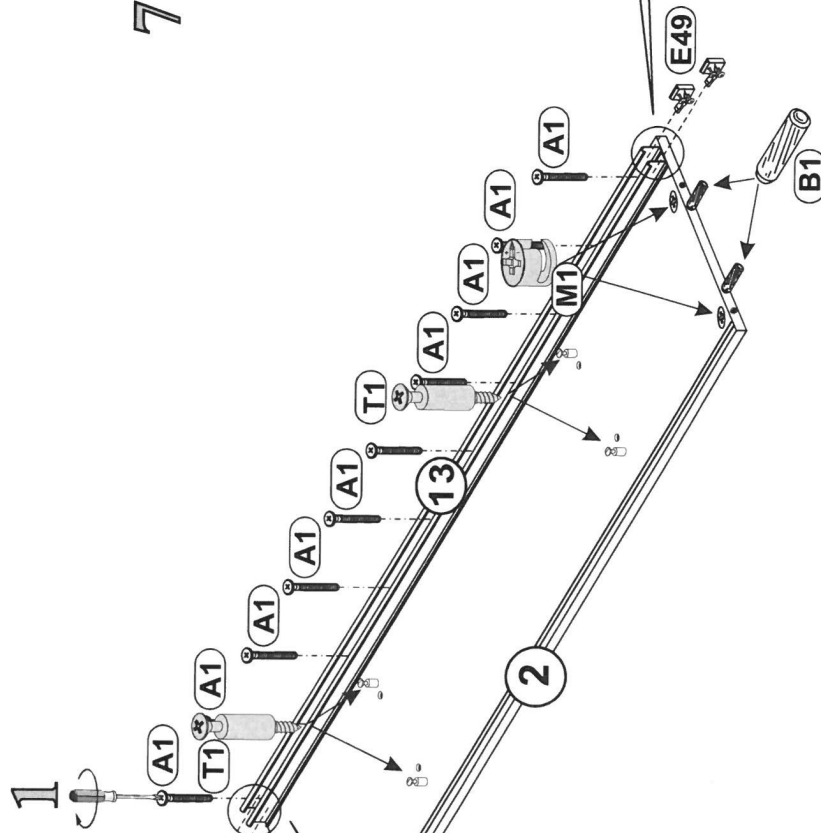
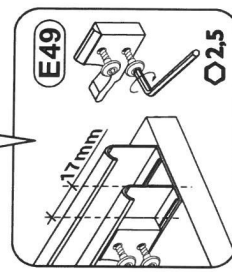

9





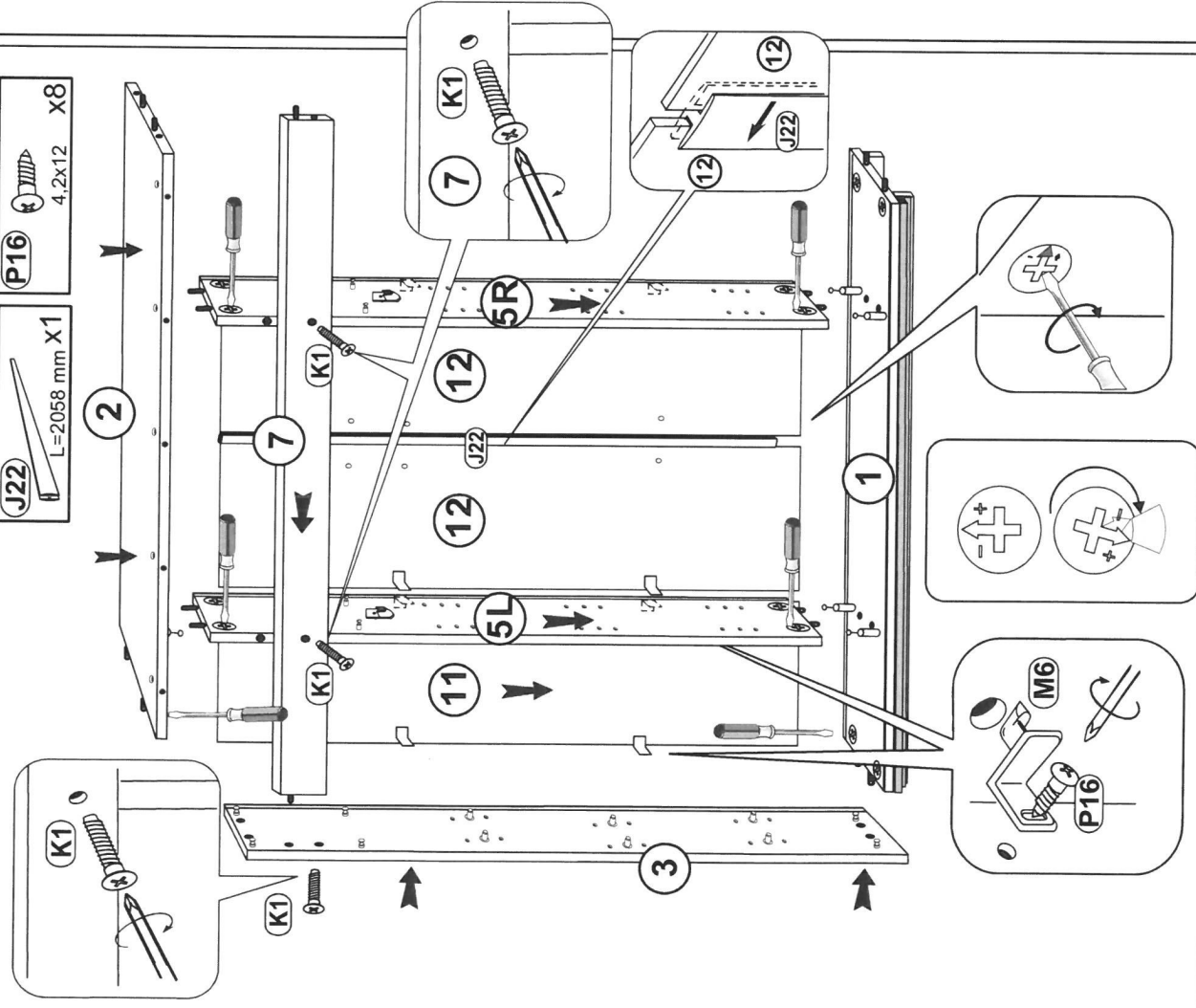

5 option "a" 

-  K1 7x50 X3
-  J22 L=2058 mm X1
-  M6 X8
-  P16 4,2x12 X8



6

-  K1 7x50 X1
-  M6 X4
-  P16 4,2x12 X4
-  M6 X4

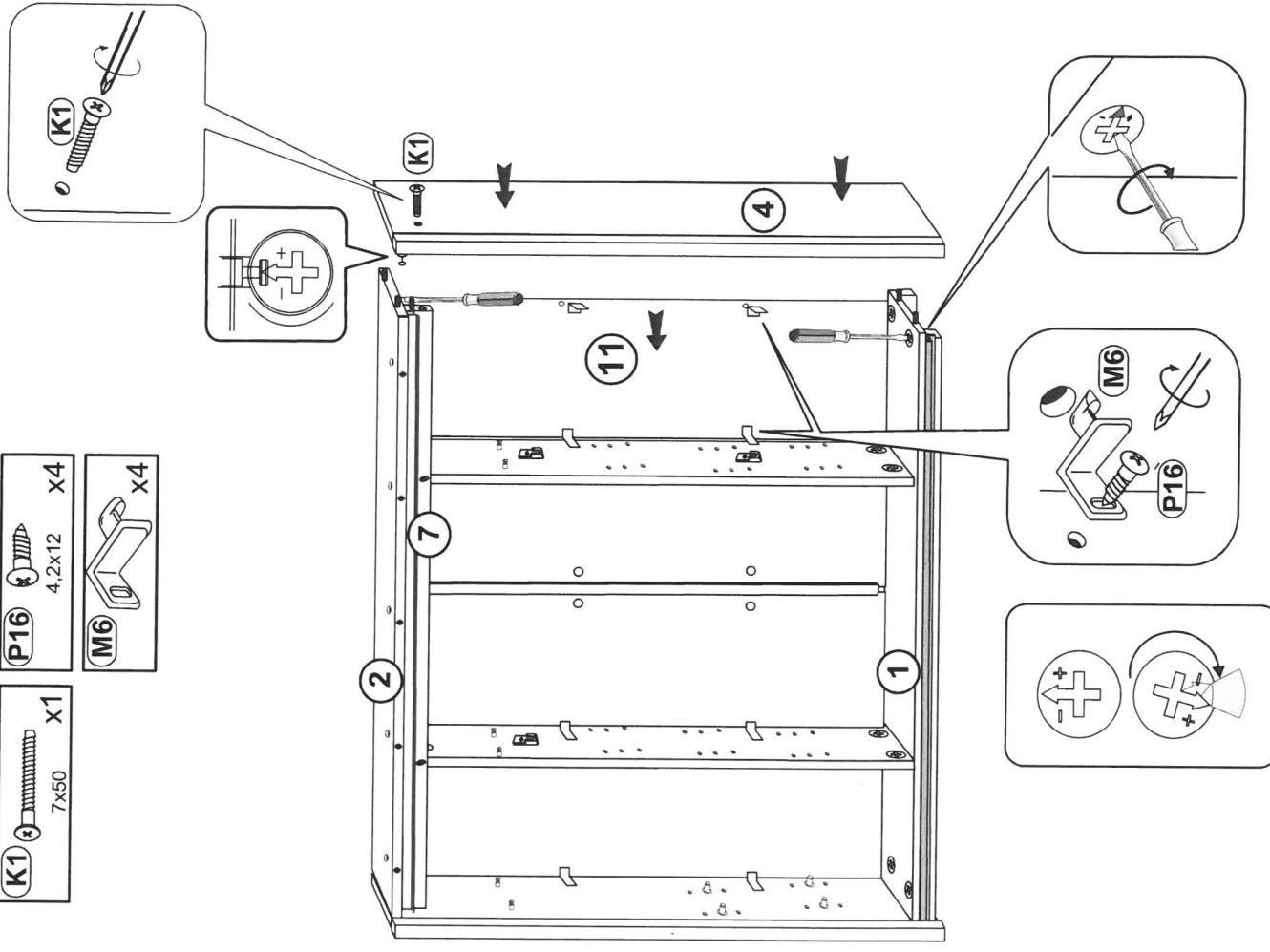



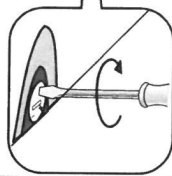
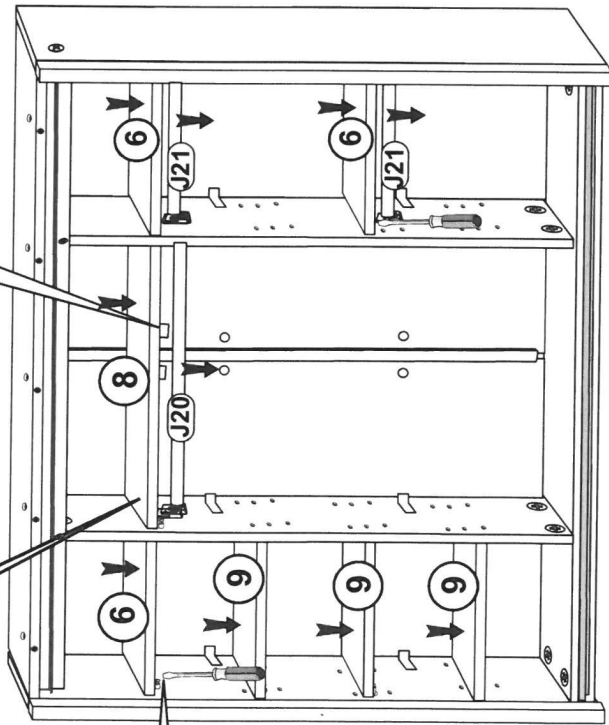
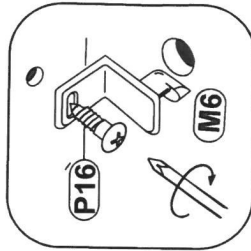
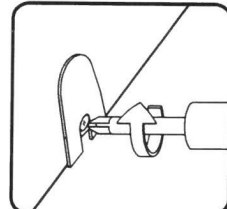
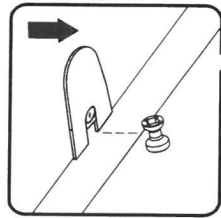
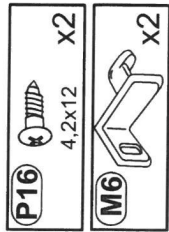

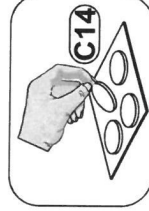
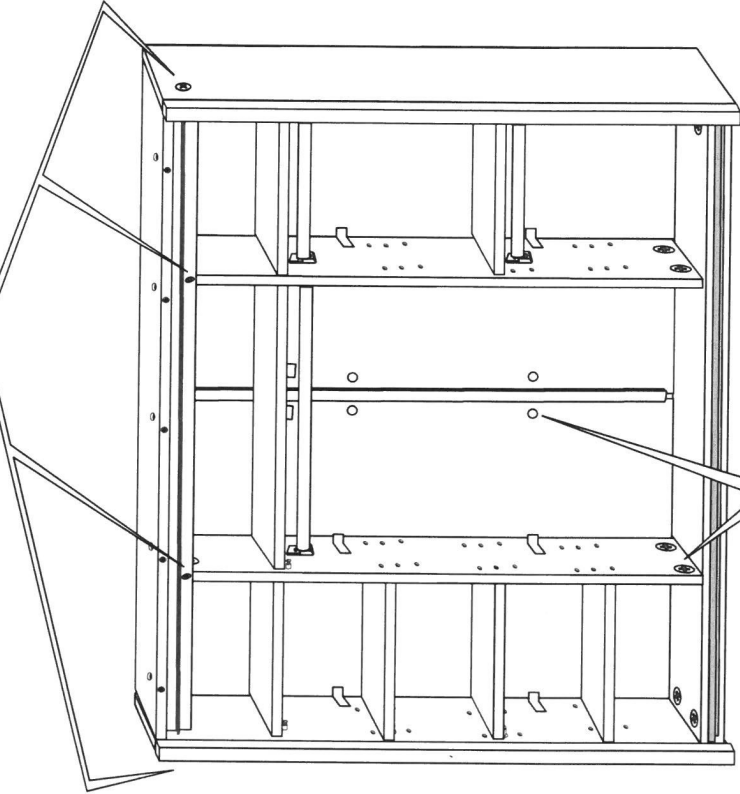
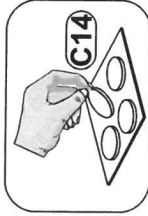

7



8



9

-  x2
-  6,3x11 x8
-  x2
-  3,5x13 mm x16
-  x2
-  6,3x11 x4

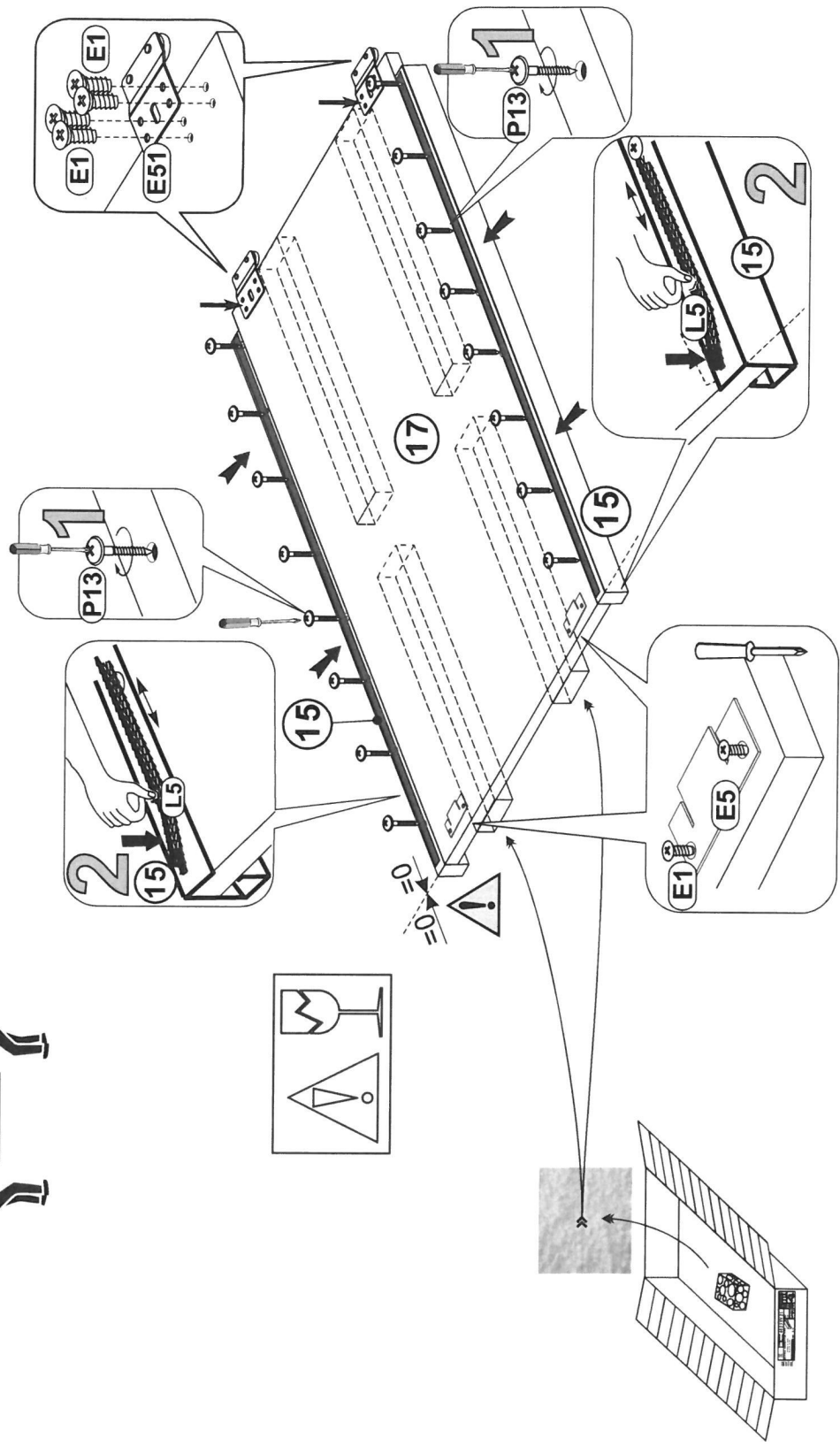
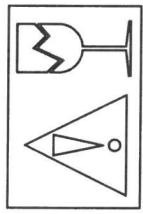
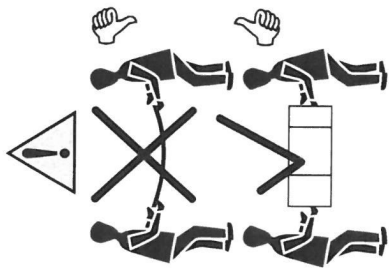
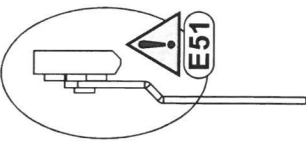

10

- E50** X4
- E1** 6,3x11 X16

- E5** X4
- E1** 6,3x11 X8

- U10** L=256 X2
- A5** M4x40 X4

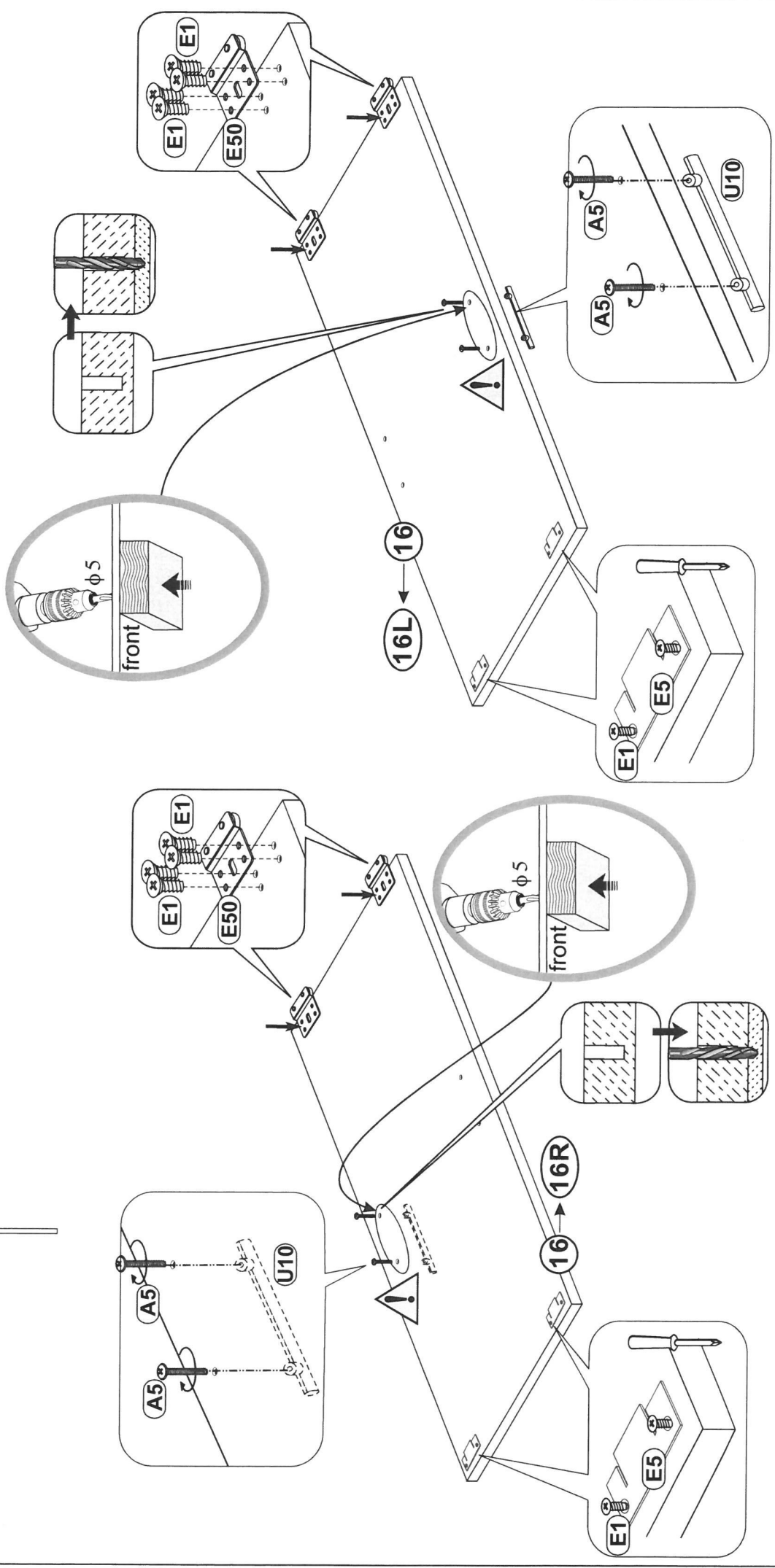
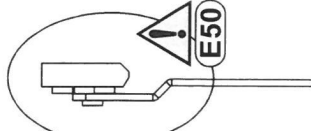

11

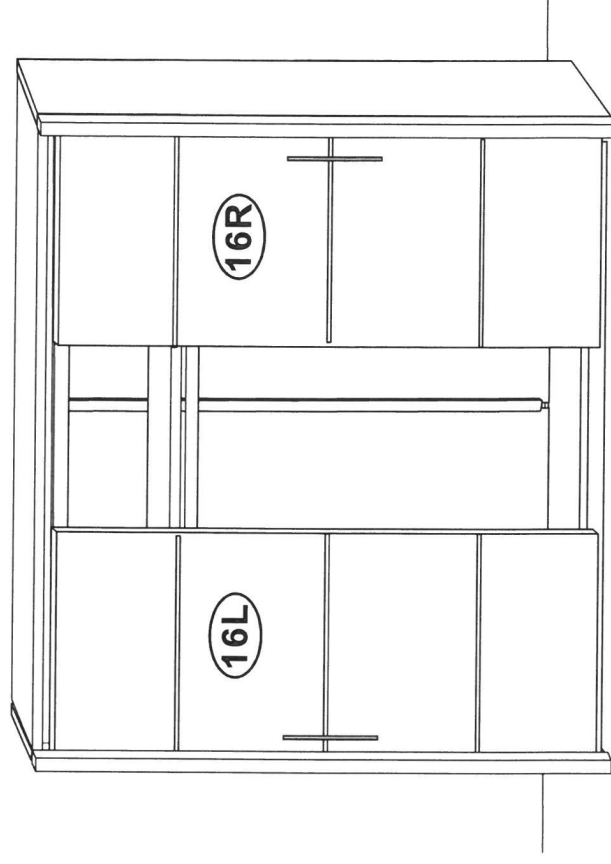
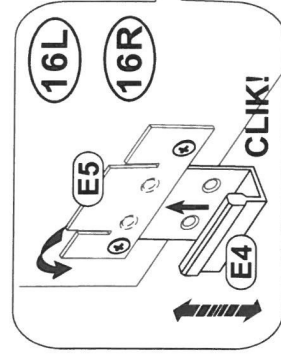
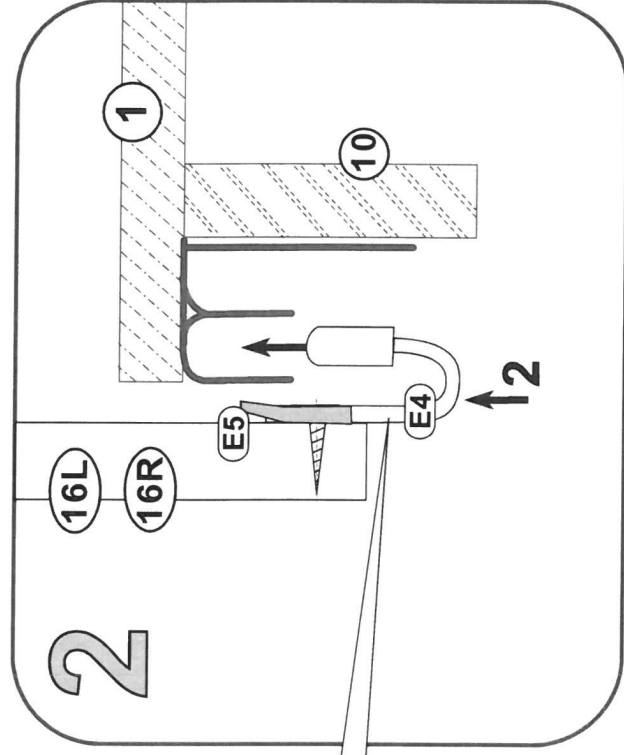
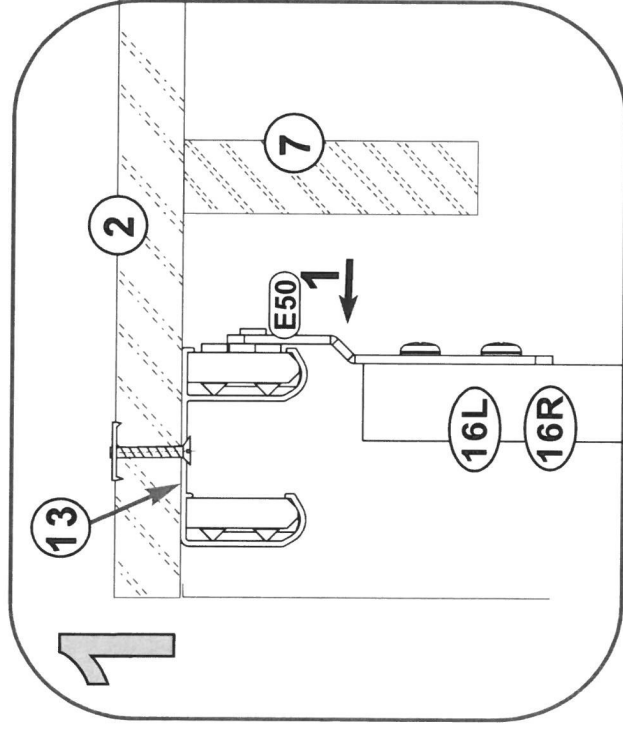
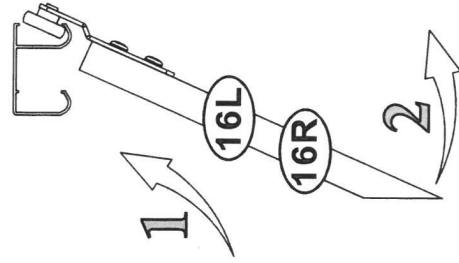
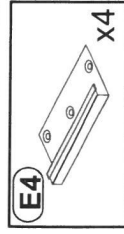

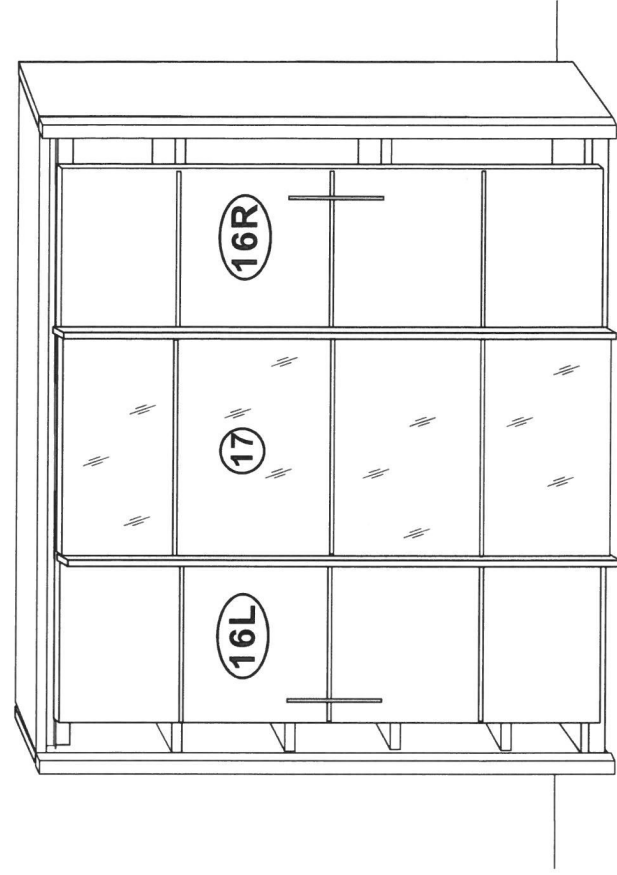
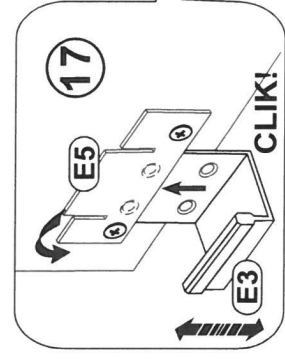
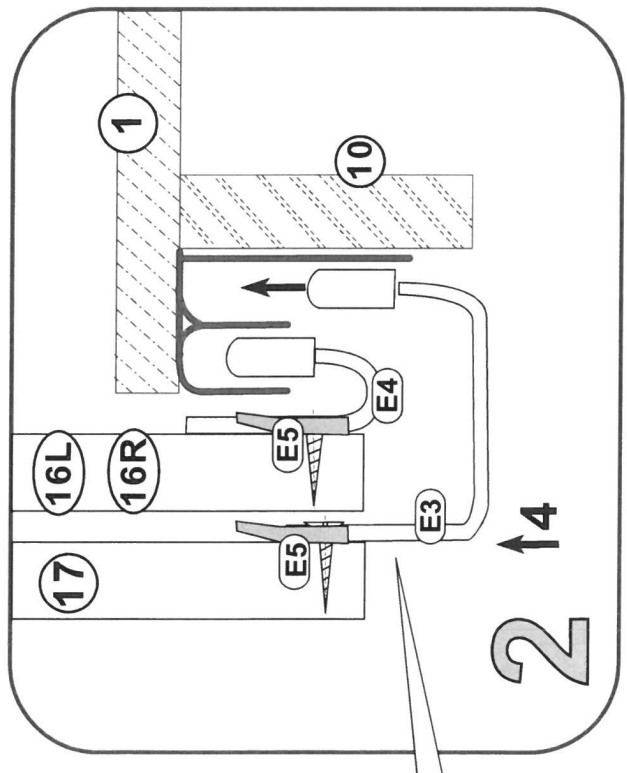
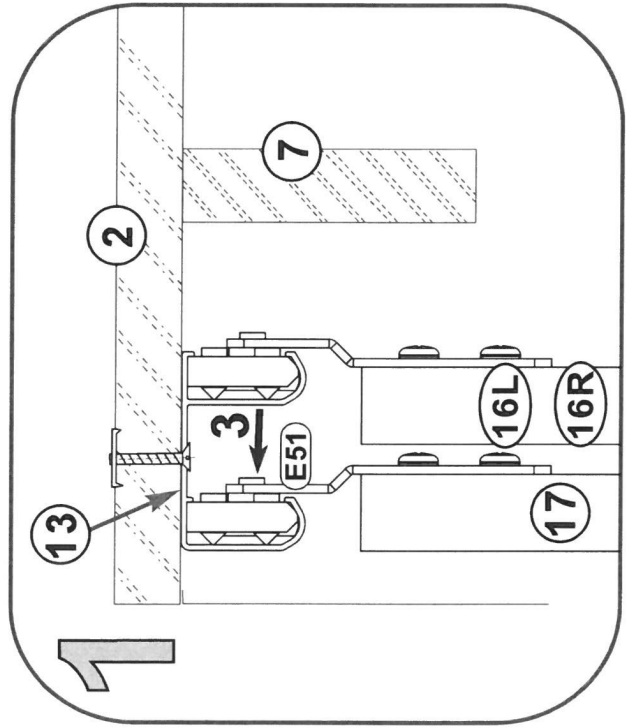
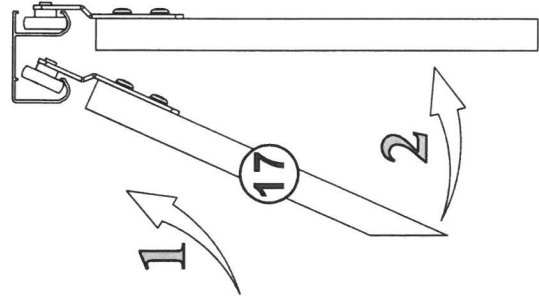



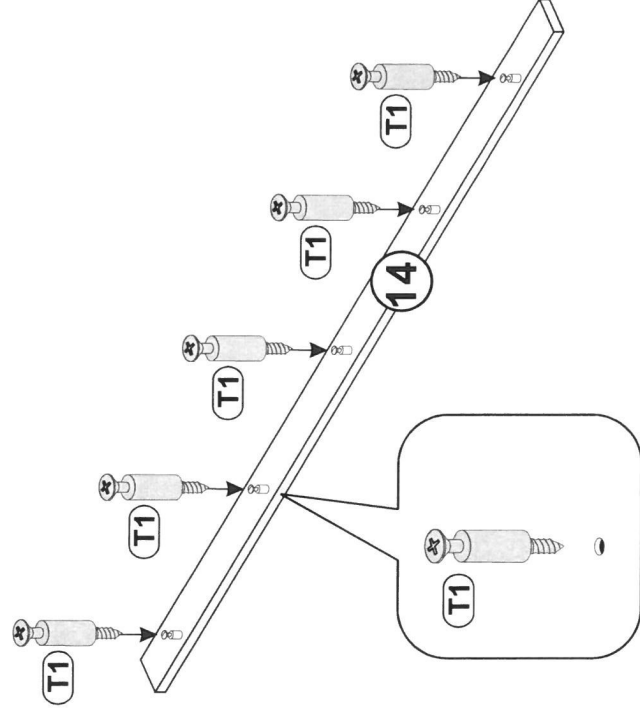
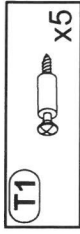

13

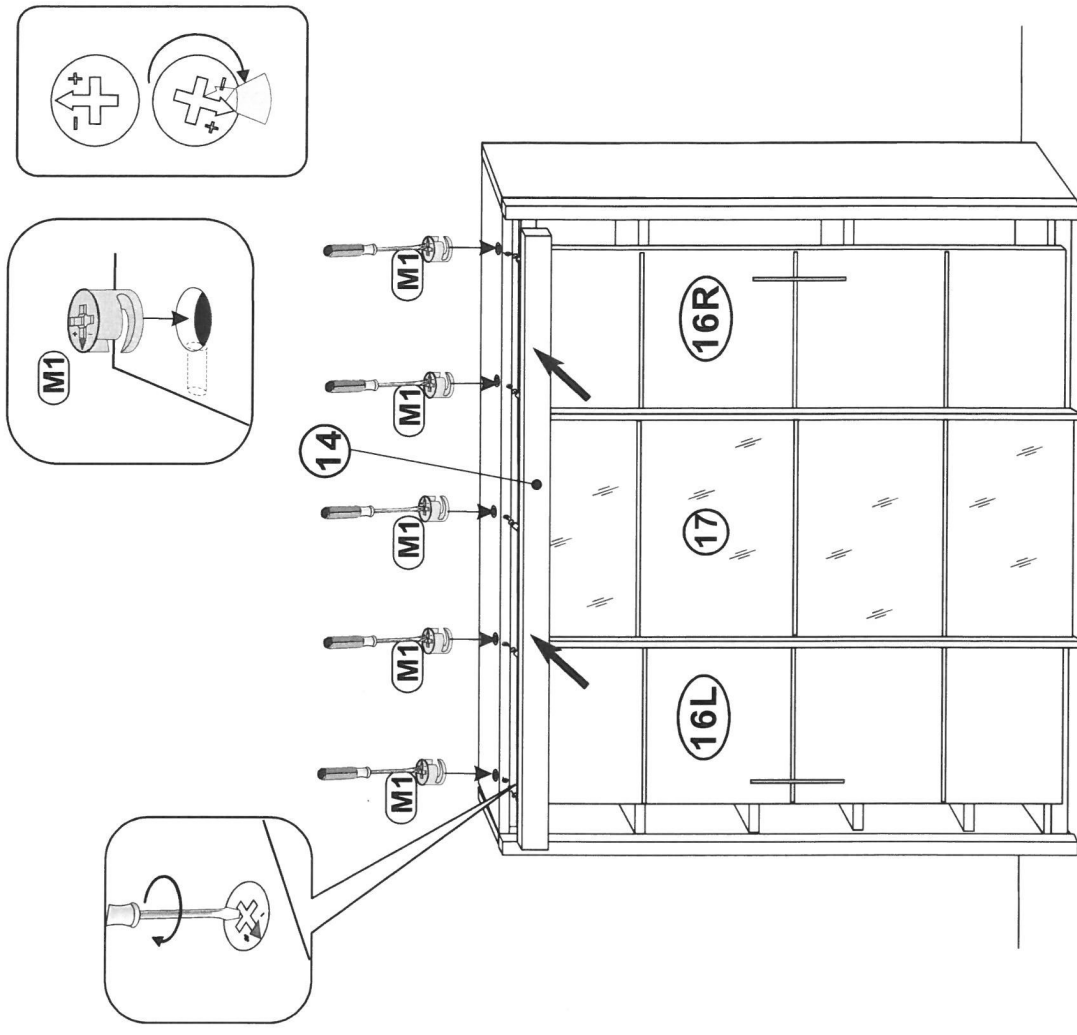

14

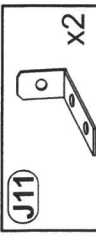

15

- L4**  x3
- J11**  x2
- P13**  3,5x13 mm x4

